



MERCURY REMOVAL IN COAL FIRED POWER PLANTS



FLUE GAS TREATMENT

Our products meet the latest emission standards for flue gas from metal smelters, steel mills, industrial boilers, cement kilns

<http://www.cabotcorp.com/solutions>

HOT FLUE GAS CLEANING

Guidelines for New Plants

Clean Development Mechanism (CDM)

Good engineering practice (GEP)

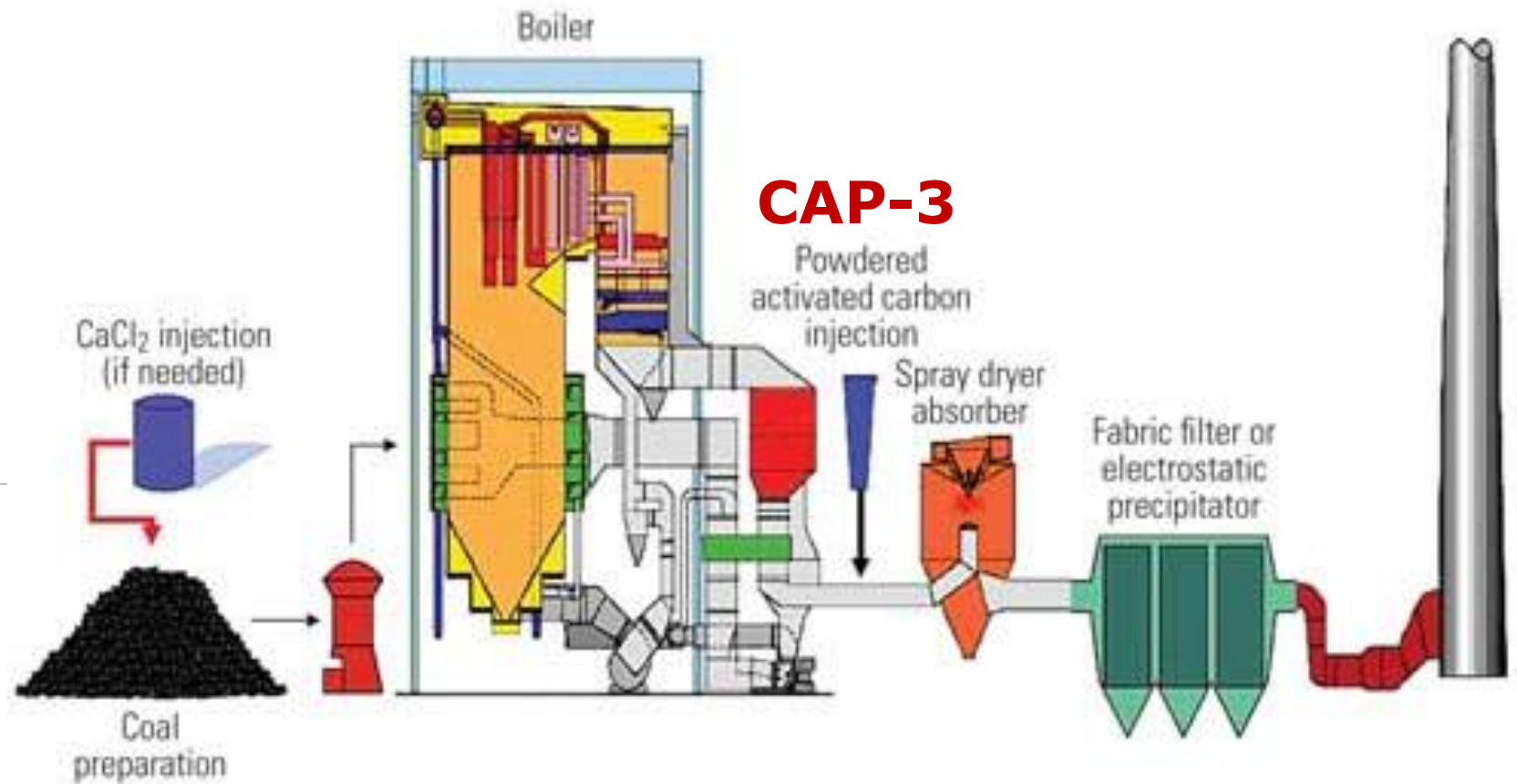

Industrialization of Kazakhstan

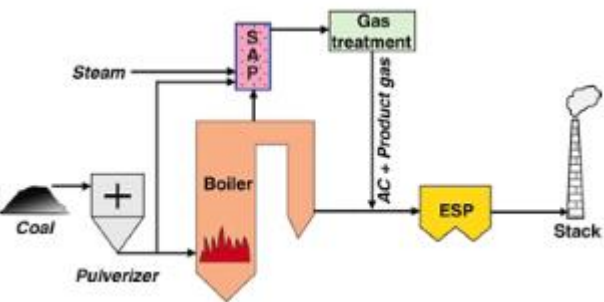

Rev-3					
Rev-2					
Rev-1					
Rev	Description	Date	Name	Check	
	Date	Drawn	Check	Appr.	Scale
	25 APRIL 2015	O.Songur	O.Songur	Y.Sidorov	NS



CAP-3



This document containing confidential information and is the property of PAKPAS and can not be reproduced or used without PAKPAS's written consent.		Job No	Page	Symbol	Unit No	Cat	Type+Format	Serial No	Rev
		1232	1/1	DWG	00	A	UD	0100.01	05



<http://www.cabotcorp.com/solutions>



FLUE GAS TREATMENT

Our products meet the latest emission standards for flue gas from metal smelters, steel mills, industrial boilers, cement kilns

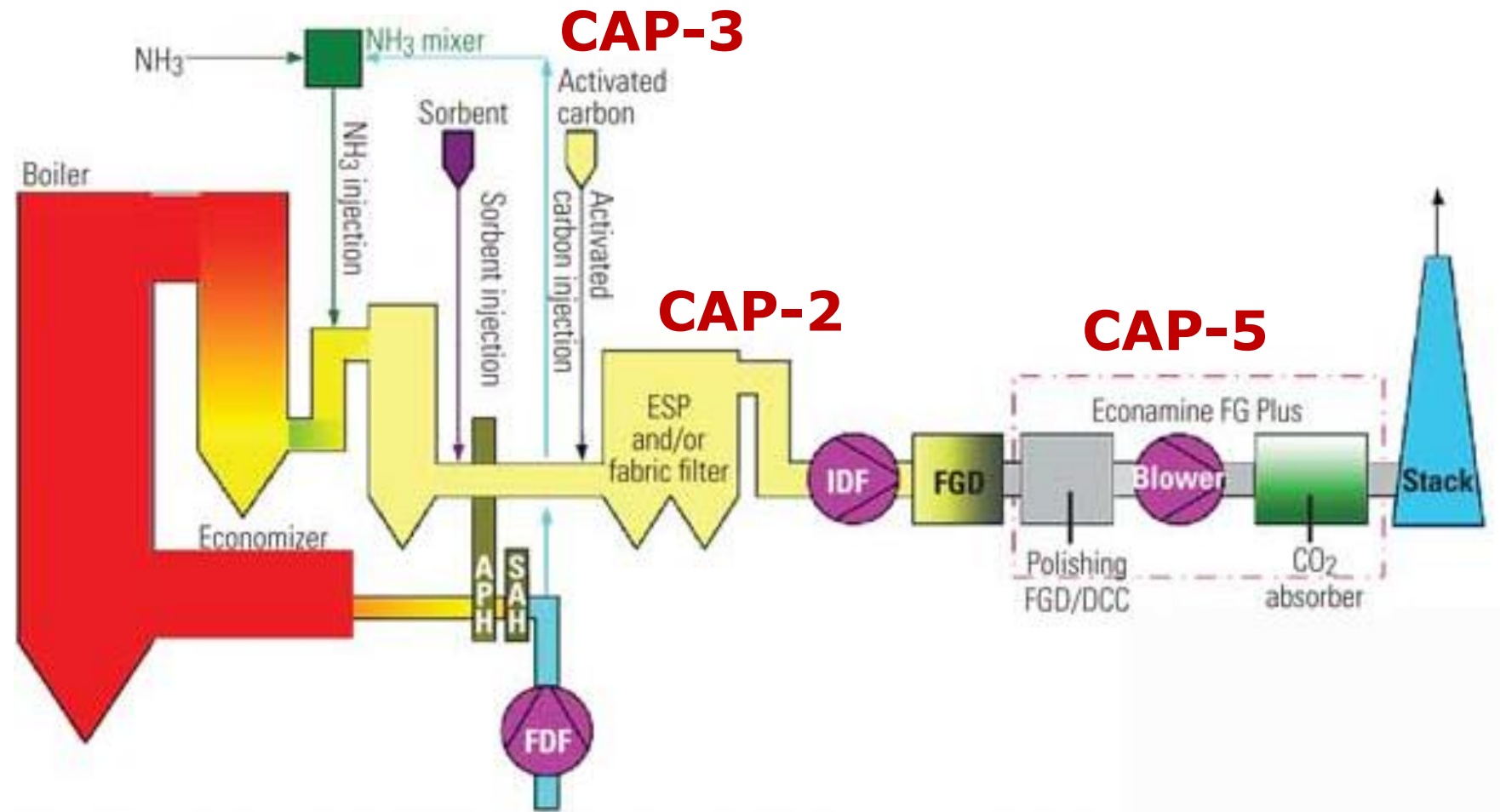

Notes: SCR = selective catalytic reduction, APH = air preheater, DCC = direct contact cooler, ESP = electrostatic precipitator, FDF = forced draft fan, FGD = flue gas desulfurization, IDF = induced draft fan, SAH = steam air heater

<http://www.powermag.com/commercially-available-co2-capture-technology/>

ACTIVATED CARBON INJECTION SYSTEMS

As a leader in purification processes, Cabot Norit Activated Carbon designs activated carbon injection (ACI) systems for a variety of needs.

ACI systems have long been recognized as an effective and cost efficient way to reduce mercury emissions from coal-fired boiler flue gases. These systems pneumatically inject powdered activated carbon (PAC) from a storage silo into the flue gas ductwork of a coal-fired power plant or cement kiln. Once dispersed into the flue gas stream, the PAC adsorbs the vaporized mercury from the flue gas and is then collected with the fly ash in the plant's particulate collection device.

Designed for lasting dependability in challenging environments, we offer a complete range of bulk silos, mobile silos, pressure vessels and bulk bag systems for both wet and dry applications. In addition to equipment, we also provide turnkey systems that include on-site installation, equipment startup, operator training and service programs.



ACTIVATED CARBON

Our activated carbon products effectively remove pollutants, contaminants and other impurities from water, air, food and beverages, pharmaceuticals and more.

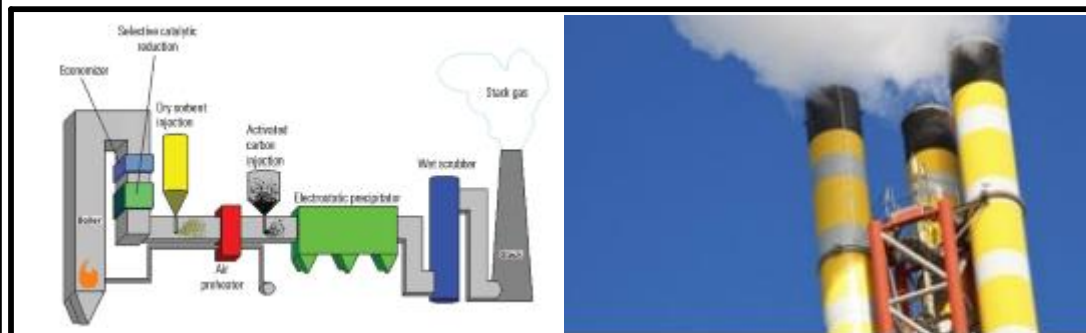
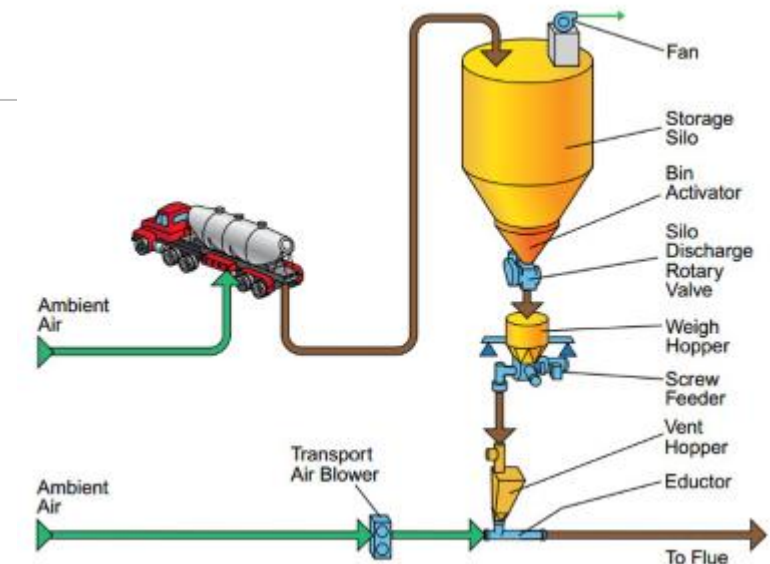

Rev-3					
Rev-2					
Rev-1					
Rev	Description	Date	Name	Check	
	Date	Drawn	Check	Appr.	Scale
	25 APRIL 2015	O.Songur	O.Songur	Y.Sidorov	NS



CAP-3



This document containing confidential information and is the property of PAKPAS and can not be reproduced or used without PAKPAS's written consent.

Job No	Page	Symbol	Unit No	Cat	Type+Format	Serial No	Rev
1232	1/1	DWG	00	A	UD	0100.02	05

Activated Carbon Injection (ACI) Storage and Handling Systems Mercury Capture...

A Continuing Emphasis for U.S. Coal-Fired Power Plants

Stringent government mercury (Hg) emission regulations at the national and state levels require large mercury emission reductions at the nation's 1,100 plus coal-fired plants, which emit approximately 48 tons of mercury per year. Among the few proven mercury emission control technologies that exist, the predominant process is Activated Carbon Injection (ACI). Powdered Activated Carbon (PAC) injection is the only control technology proven to reduce mercury emissions in excess of 90%.

PAC Storage and Handling Systems

The cornerstone of Metalfab's PAC Storage and Handling System is the integration of the company's proven bin activators, activated Posibins™ and "Better-Weigh®" gravimetric feeders. These critical system components are integrated with process controls, instrumentation, knife gate valves, and interconnecting piping, all pre-installed within the skirt area beneath a fully engineered storage silo. This integrated system provides precise PAC metering to the final downstream injection system feeding the flue gas ductwork.

Metalfab successfully combines testing, equipment design, and system integration capabilities to offer fully integrated PAC handling systems directly to large environmental/boiler OEMs who supply complete ACI systems to power plants.

Features

- Fully Integrated System with Field-Proven Equipment and Performance
- Unique, Adjustable, Secondary Discharge Baffle
- Bin Activator Designed to Improve Density of PAC
- Adjustable Vibration Force on Bin Activators and Distribution Hoppers
- Significantly Greater Minute-to-Minute Feed System Accuracy
- No Additional Compressed Air Requirement Beyond Instrument Air
- Even Draw-Down of PAC from Silo to Feeders
- Highly Efficient "Better-Weigh®" Gravimetric Screw Feeder with Only Two Moving Parts
- Simple Screw and Tube Change
- PLC-Based Controls and Monitoring with Easy-to-Use Touch Screen Displays



<http://www.metalfabinc.com/product.cfm?prod=powdered-activated-carbon>

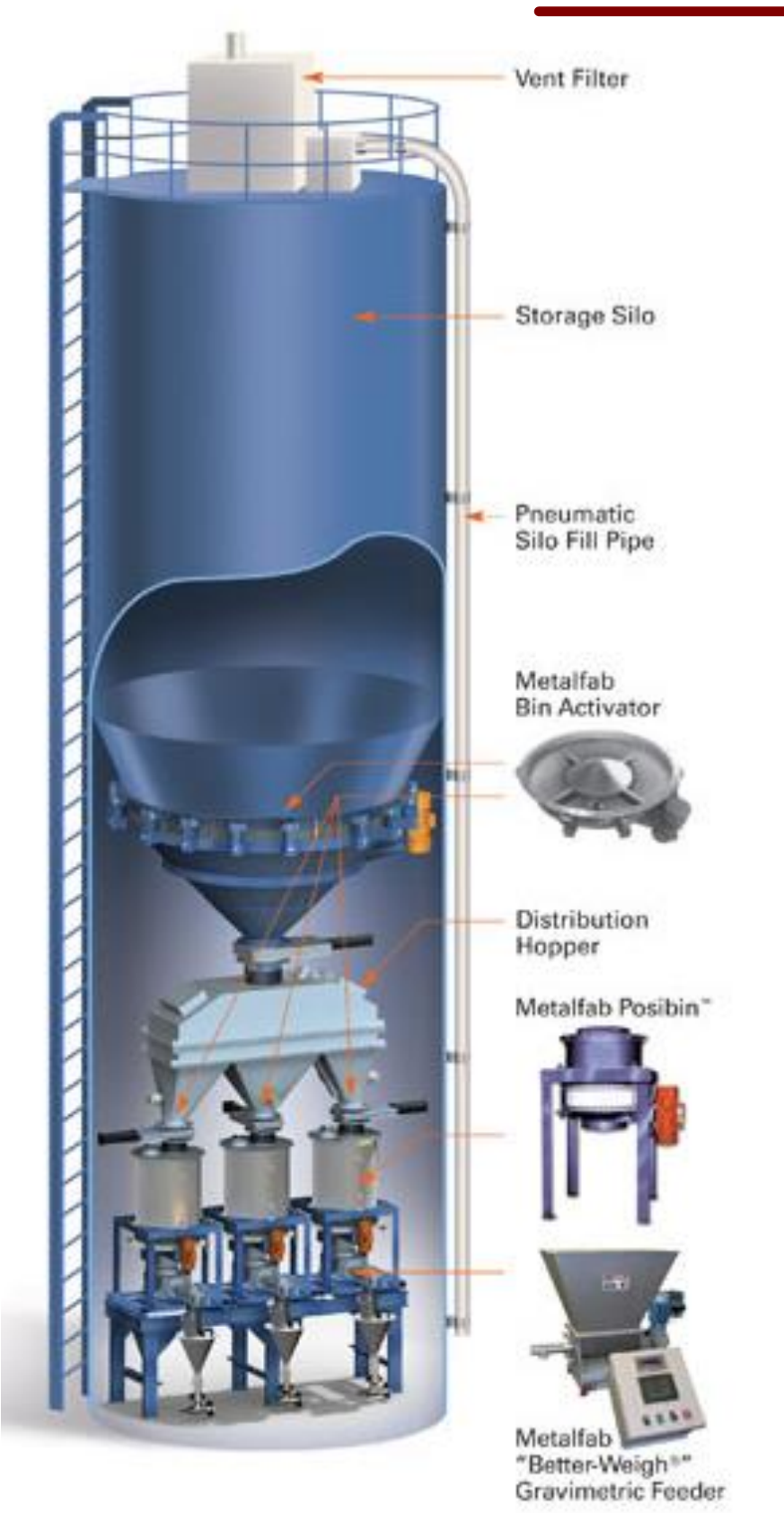

GRAVIMETRIC FEEDER



<http://www.metalfabinc.com/product.cfm?prod=powdered-activated-carbon>

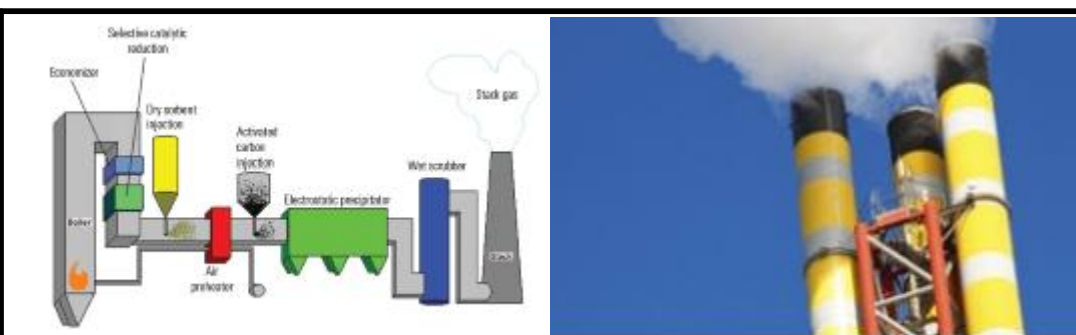

Rev	Description	Date	Name	Check
Rev-3				
Rev-2				
Rev-1				
Date	Drawn	Check	Appr.	Scale
25 APRIL 2015	O.Songur	O.Songur	Y.Sidorov	NS

						<p>CAP-3</p>					
Job No	Page	Symbol	Unit No	Cat	Type+Format	Serial No	Rev				
1232	1/1	DWG	00	A	UD	0100.03	05				